



COMPONENTI MECCANICI
PER ASCENSORI
MECHANICAL LIFT
COMPONENTS

LIMITATORE DI VELOCITA'
LK.300 APPESO

OVERSPEED GOVERNOR
LK.300 TO HANG UP

T-242

COD.8024202300

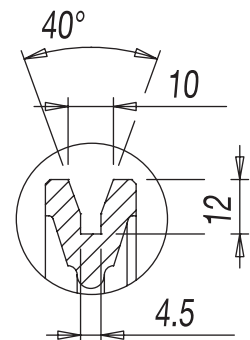
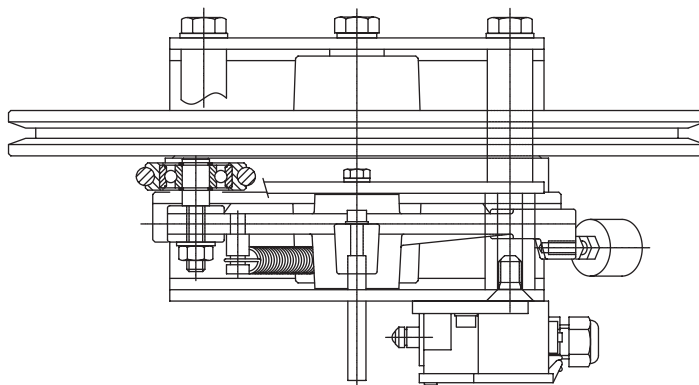
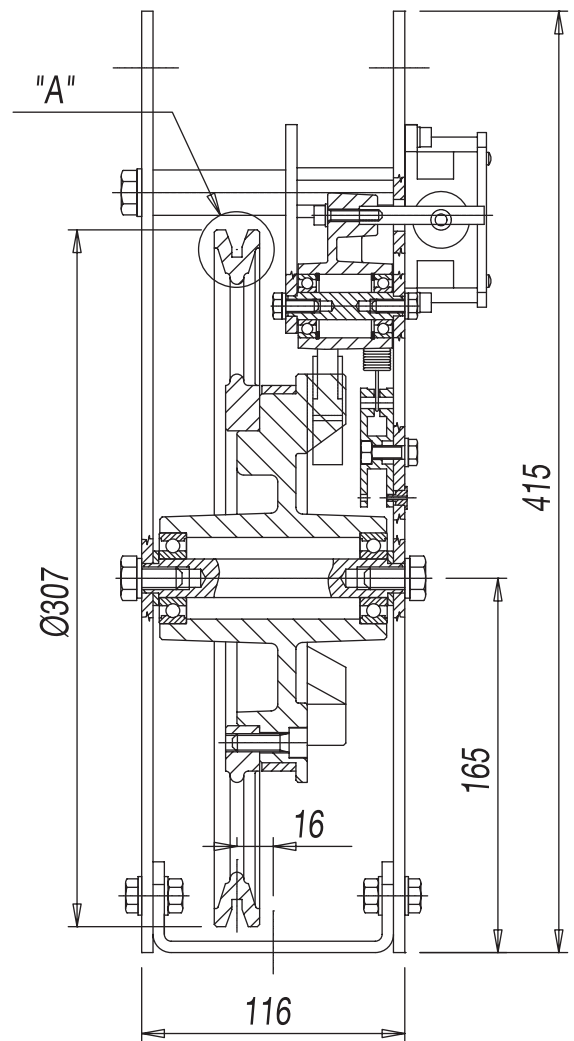
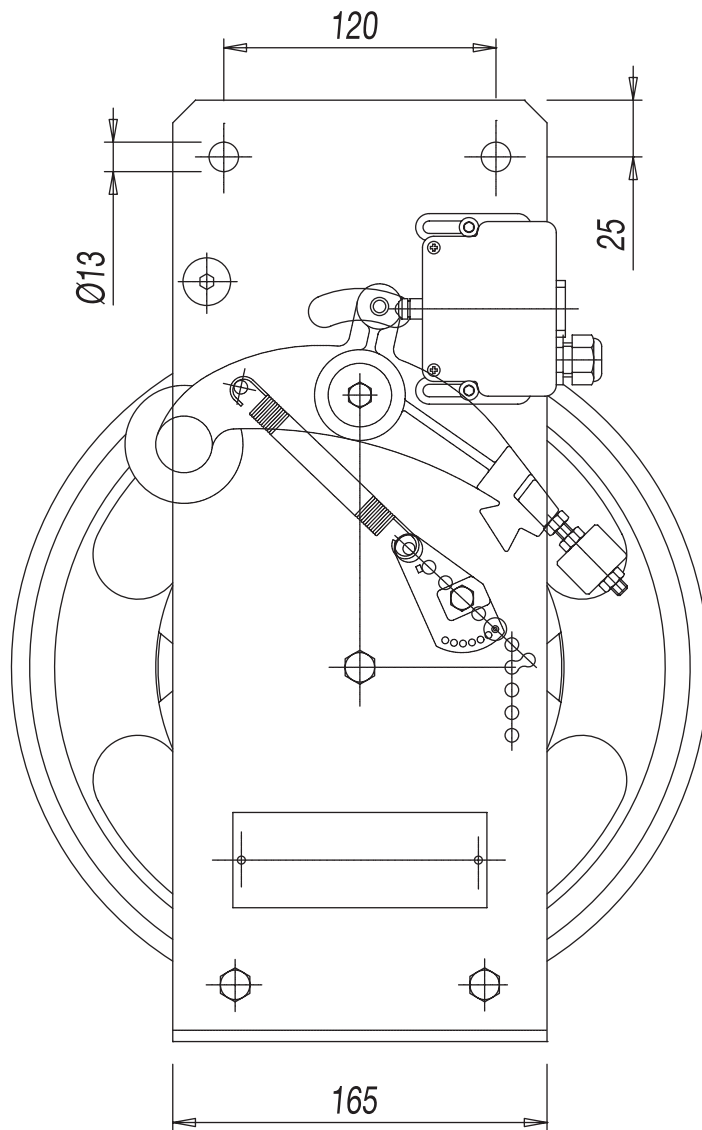

INGRANDIMENTO "A"
ENLARGEMENT "A"

- ROTAZIONE BIDIREZIONALE
- VELOCITA' NOMINALE : 0-2,37 m/s
- VELOCITA' INTERVENTO : 0,40-2,73 m/s
- Ø FUNE : 6-8 mm.
- PESO : 14 Kg.
- GOLA INDURITA
- PIASTRA AGGIUNTIVA SMONTABILE

Per il mercato russo
verificare i dati tecnici
sui nostri certificati russi

For the Russian market
verify the technical data
on our Russian
certificates

- BIDIRECTIONAL ROTATION
- NOMINAL SPEED : 0-2,37 m/s
- TRIPPING SPEED : 0,40-2,73 m/s
- Ø ROPE : 6-8 mm.
- WEIGHT : 14 Kgs.
- HARDENED GROOVE
- ADDITIONAL PLATE DISMONTABLE